

# Splitface / Smoothface

CONCRETE MASONRY UNITS



SANDCASTLE (Custom Color)

COUNTY MATERIALS CORPORATION



# Splitface

CONCRETE  
MASONRY UNITS

Concrete masonry allows you to build with one unit and a single laying operation. Available in a wide selection of sizes and colors, Splitface units eliminate the need for additional wall coverings. Concrete masonry is compatible with all roofing systems and has excellent load-bearing capacity for supporting multistory structures. The cavities in concrete block can accommodate vertical steel reinforcement for enhanced structural integrity.

## Functional Aesthetics

- Ideal for commercial, industrial, institutional, and residential applications
- Minimal maintenance
- Compatible with all roofing systems
- Eliminate the need for additional wall coverings
- Available in many integral color blends

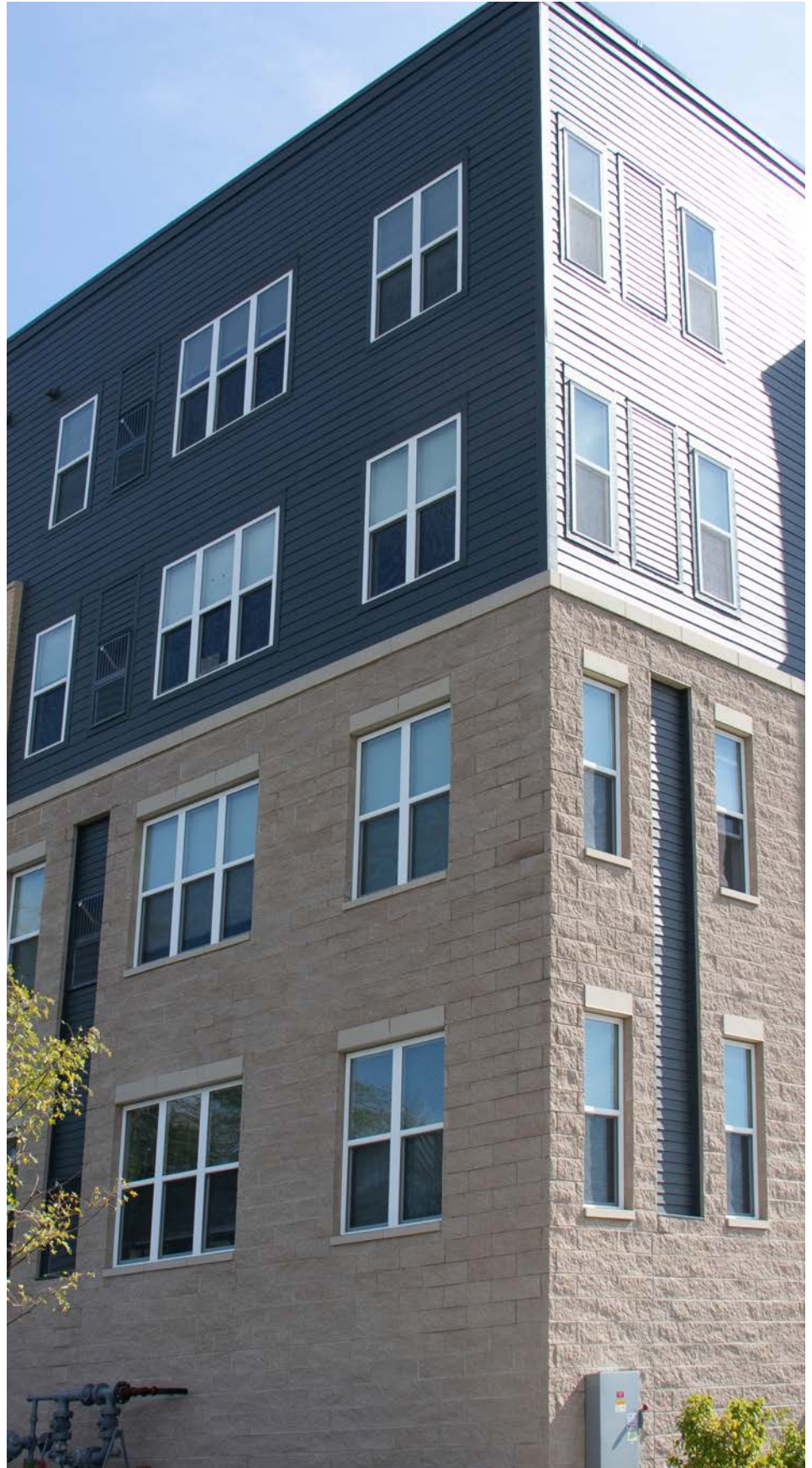

BISQUE



Color options manufactured in Appleton, Wis. Plant



White (18-006C)



Salt & Pepper (18-004C)



Sandstone (18-314C)



Pebble Beach (18-002C)



Light Cream (18-079C)



Cream (18-080C)



Bisque (18-121C)



Sienna Cream (18-082C)

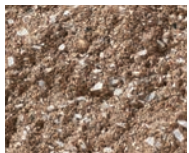

Western Sand (18-120B)

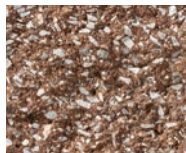

Coral Brown (18-571B)



Tumbleweed (18-122A)



Adobe (18-070A)



Brown (18-068A)



Buff (18-074A)

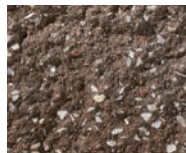

Mocha (18-123A)



Espresso (18-126A)



Autumn Red (18-124A)



Natural (18-000A)



Steel Gray (18-348A)



Blackened Ash (18-064A)

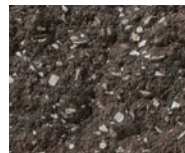

Dark Chocolate (18-072A)

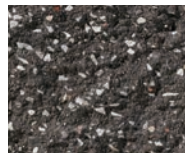

Charcoal (18-078A)

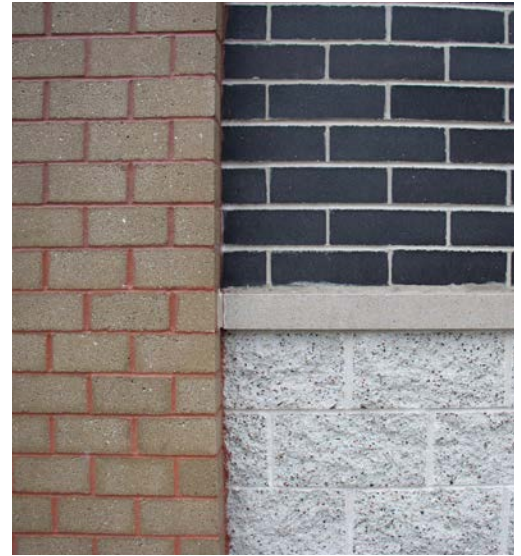

**Letter following color names denote pricing levels. "A" indicates lowest price level; "C" is highest price level.**

*Colors, product data, and availability are subject to change without notice. Please confirm all details with a County Materials representative for availability in your area. Colors shown may vary from actual hues and should only be used as a guide. Refer to actual product samples for final color selection.*

Color options manufactured in Roberts, Wis. Plant



White (12-006C)

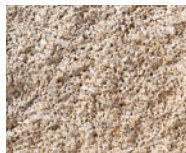

Cream (12-080C)

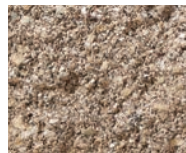

Desert Edge (12-704A)

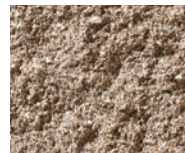

Tan Warmstone (12-032C)

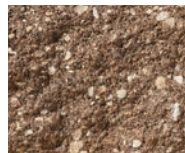

October Oak (12-052A)

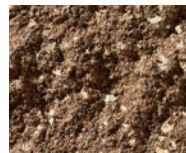

Fawn (12-088A)

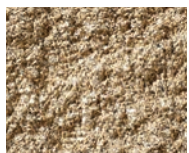

Bisque (12-121C)

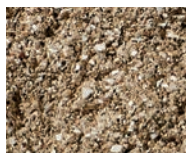

Sienna Cream (12-082C)

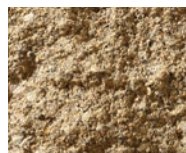

Buttercup (12-234B)



Tumbleweed (12-122A)

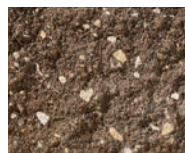

Taupe (12-032A)

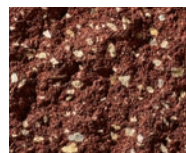

Brick Rose (12-012A)

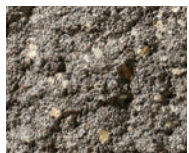

Gray (12-000A)

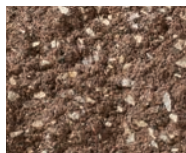

Pacific Beach (12-027A)

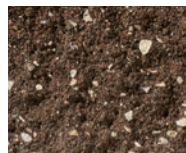

Desert Castle (12-030A)

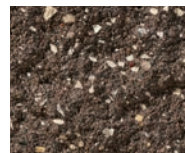

Mushroom (12-028A)

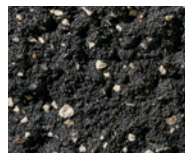

Blackened Ash (12-064A)

# Splitface Concrete Masonry Units

SHAPES AND SIZES



## SPLITFACE CONCRETE MASONRY UNITS

SPLITFACE masonry units lend a **refined beauty of hewn, chiseled stone** to architecture – qualities that convey permanence and stability. The randomly textured face and rugged pattern of split units creates an ever-changing visual scenery on buildings throughout the day. SPLITFACE masonry is a durable yet versatile design option for commercial, industrial, institutional and residential construction.

## SPLITFACE LOAD-BEARING & FULL VENEER UNITS

Stretcher

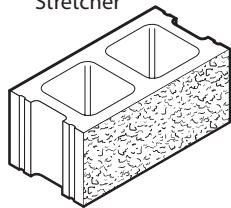

Half High Stretcher

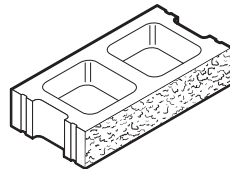

4" "L" Corner  
Full Face Split

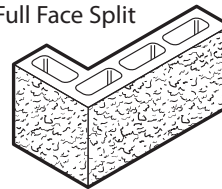

4" x 8" Full Face Split End



12" or 16"  
Available

4" or 8"  
Available

Unit Availability	NOMINAL WIDTHS						
	4"	6"	8"	10"	12"	14"	16"
Stretcher			✓	✓	✓	✓	✓
Flush End/Sash/Splittable			✓	✓	✓	✓	✓
Bond Beam		✓	✓	✓	✓	✓	✓
Double Flush End	✓	✓	✓	✓	✓	✓	✓
All Solid	✓						
Half Block – 8" Long			✓	✓	✓		
Half High – 4" High	✓	✓	✓	✓	✓		
Corner Configurations	8" Corner / 4" "L" Corner / 4" Corner 12" Long						

Contact your sales rep for: stocking and/or special order status, water repellent, integral color options, etc.

*Note: Not all block immediately available at all County Materials locations.*

*All oversize block are custom ordered.*

*Oversize block produced in Janesville, Burnished colors only.*

*Corners can only be produced in up to 16" lengths.*

*All dimensions nominal.*

Oversize 4" x 4" x 24"

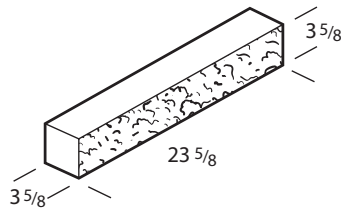

Oversize 4" x 8" x 24"

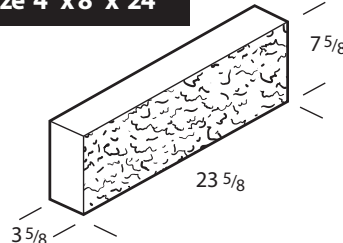

Oversize 4" x 12" x 12"

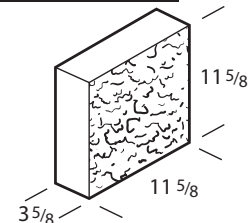

Oversize 4" x 12" x 16"

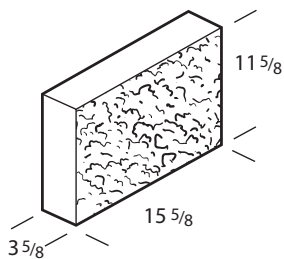

Oversize 4" x 12" x 24"

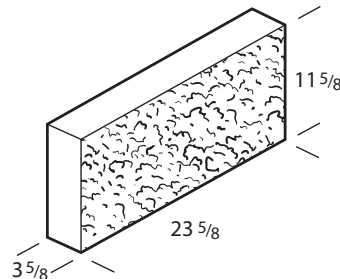

Oversize 4" x 16" x 16"

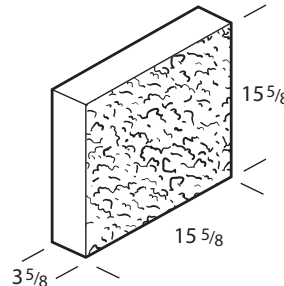

Oversize 4" x 16" x 24"

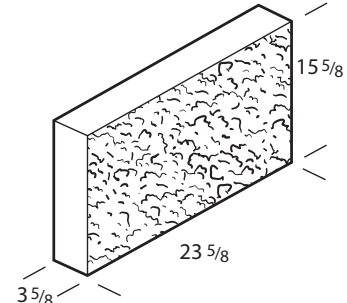



# Splitface Concrete Masonry Units

## SHAPES AND SIZES



### SPLITFACE THIN VENEERS – FIELD APPLIED

#### Modular

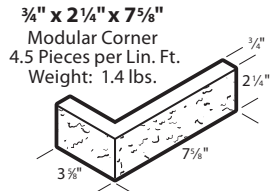
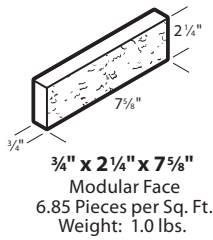

#### Utility

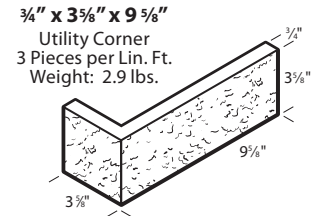
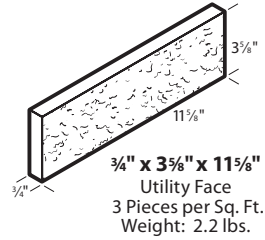

#### Half High

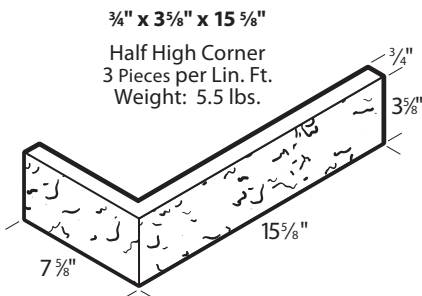
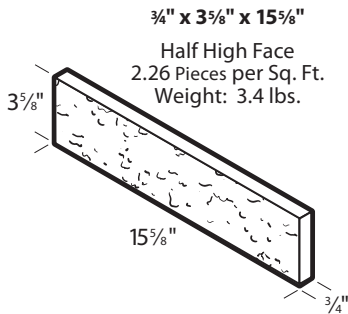

#### Full High

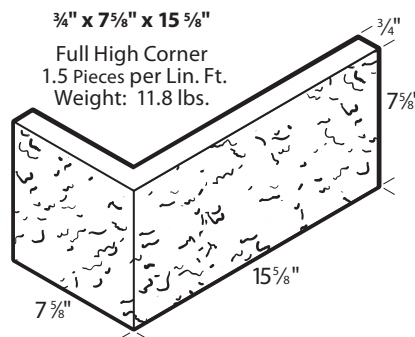
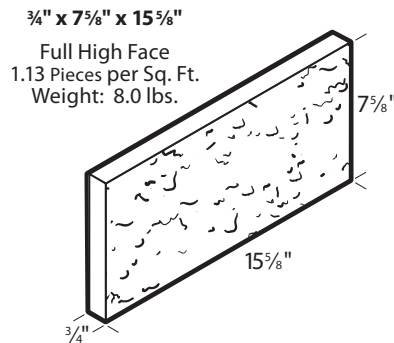

*Note: Splitface thickness will range from 3/4" to 1 1/4" thick on applicable sizes. All dimensions nominal.*

# Splitface Concrete Masonry Units with Score(s)

## SHAPES AND SIZES



### SPLITFACE / ROCKFACE BLOCK WITH SQUARE OR ROUND SCORE(S)

Present symmetrical lines and formality to walls with tooled scored splitface units.

SCORED SPLITFACE are divided into 2, 4, 6 or 8 vertical split ribbed sections.

These ribs are proportioned for vertical alignment in either a running or stacked bond placement. *Call for availability.*

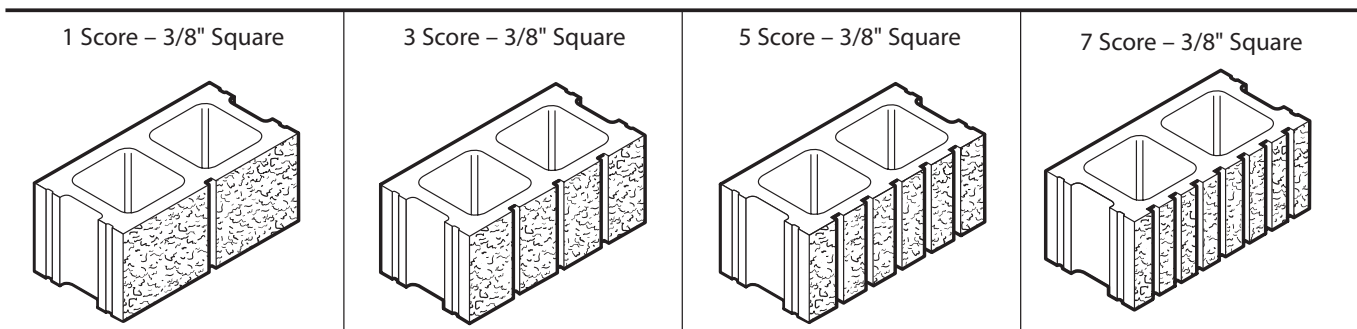

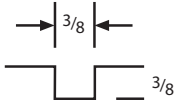
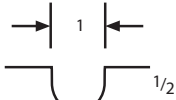
Score Options	Unit Availability	NOMINAL WIDTHS							
		4"	6"	8"	10"	12"	14"	16"	
<p>3/8" Square Score*</p>  <p>Available Scores: 1, 3, 5, 7</p>	<p>1" Round Score*</p>  <p>Available Scores: 7 (Available in 8" units only)</p>	<b>CONFIGURATION</b>							
		<b>Stretcher</b>			✓	✓	✓	✓	
		<b>Flush End/Sash/Splittable</b>	✓	✓	✓	✓	✓	✓	
		<b>Bond Beam</b>		✓	✓	✓	✓	✓	
		<b>Double Flush End</b>	✓	✓	✓	✓	✓	✓	
		<b>All Solid</b>	✓						
		<b>Half High - 4" High</b>	✓		✓	✓	✓		
		<b>Corner Configurations</b>	1 Score: 8" Return Corner / 4" "L" Corner 3, 5, or 7 Scores: 8" Return Corner						

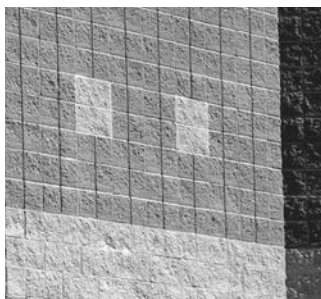

**Contact your sales rep for:** stocking and/or special order status, water repellent, integral color options, etc.

\* Depth and width of scores vary by manufacturing location. Contact your local County Materials representative for information.

*Note: Not all block immediately available at all County Materials locations  
All dimensions nominal.*

# Splitface Concrete Masonry Units with Score(s)

## SHAPES AND SIZES



### SPLITFACE / ROCKFACE BLOCK WITH DEEP V SCORE(S)

1 Score – 7/8" Deep V

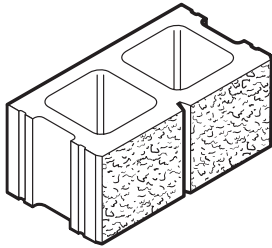

3 Score – 7/8" Deep V

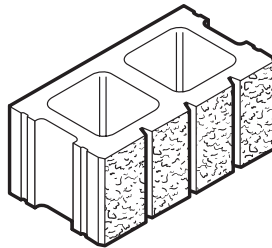

5 Score – 7/8" Deep V

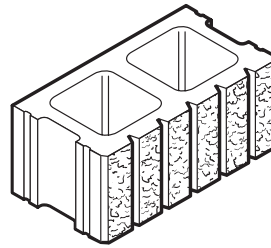

#### Score Options

7/8" Deep V Score\*

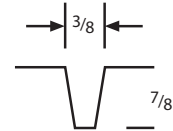

Available Scores: 1, 3, 5

Unit Availability	NOMINAL WIDTHS						
	4"	6"	8"	10"	12"	14"	16"
Stretcher			✓		✓		
Flush End/Sash/Splittable			✓		✓		
Bond Beam			✓		✓		
All Solid	✓						
Corner Configurations	1 Score: 8" Return Corner / 4" "L" Corner 3, 5, or 7 Scores: 8" Return Corner						

#### Contact your sales rep for:

stocking and/or special order status, water repellent, integral color options, etc.

\* Depth and width of scores vary by manufacturing location. Contact your local County Materials representative for information.

*Note: Not all block immediately available at all County Materials locations. All dimensions nominal.*

# Transplit® Block

SHAPES AND SIZES



## TRANSPLIT® BLOCK

Fullface split and smooth face units are uniquely combined in one unit.

TRANSPLIT BLOCK allow roof flashing to be installed against a smooth surface for **water penetration integrity**, while maintaining the aesthetic features of your building. TRANSPLIT BLOCK can also be used to create accent bands.

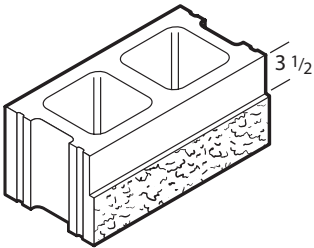
Transplit 	Unit Availability	NOMINAL WIDTHS						
	CONFIGURATION	4"	6"	8"	10"	12"	14"	16"
Stretcher				✓	✓	✓		
Flush End/Sash/Splittable				✓	✓	✓		
Bond Beam				✓	✓	✓		
Double Flush End	✓	✓	✓	✓	✓	✓		
Corner Configurations	Field Mitered Corners							
<p><b>Contact your sales rep for:</b> stocking and/or special order status, water repellent, integral color options, etc.</p>								



*Note: Not all block immediately available at all County Materials locations.  
All dimensions nominal.*



# Smoothface

CONCRETE  
MASONRY UNITS

Smoothface units provide an attractive alternative to standard concrete masonry units with their ultra-smooth, modern surface used to create contemporary façades that stand the test of time.

## Refined and Reliable

- Ideal for commercial, industrial, institutional, and residential applications
- Minimal maintenance
- Compatible with all roofing systems
- Eliminate the need for additional wall coverings
- Available in many integral color blends



**(800) 242-7733**  
**countymaterials.com**  
info@countymaterials.com

©2023 County Materials Corporation • 1091166900\_0523

SLATE and CHARCOAL

COUNTY MATERIALS CORPORATION